

VAB 040-032-110 0222KI T81MVCCO OA

Vitacast Bloc - Hygienic centrifugal pump

Operating data

Requested flow rate	8.00 m ³ /h	Actual flow rate	8.00 m ³ /h
Requested developed head	16.00 m	Actual developed head	16.00 m
Pumped medium	+ Starch suspension + waterige suspensie met droge substantie	Efficiency	47.7 %
Pumped medium details	Not containing chemical and mechanical substances which affect the materials	Power absorbed	0.80 kW
Max. ambient air temperature	20.0 °C	Pump speed of rotation	3117 rpm
Min. ambient air temperature	20.0 °C	NPSH required	1.10 m
Fluid temperature	60.0 °C	Permissible operating pressure	10.00 bar.g
Fluid density	1100 kg/m ³	Discharge press.	1.73 bar.g
Fluid viscosity	1.10 mm ² /s	Shutoff head	18.38 m
Suction pressure max.	0.00 bar.g	Min. allow. flow for continuous stable operation	1.02 m ³ /h
Mass flow rate	2.44 kg/s	Min. allow. mass flow for continuous stable operation	0.31 kg/s
Max. power on curve	0.93 kW	Max. allow. mass flow Design	3.76 kg/s Single system 1 x 100 %

Design



The pump conforms to the regulations of EGV 1935/2004.

Design	Close-coupled
Orientation	Horizontal
Suction nominal dia.	DN 40
Suction nominal pressure	PN 10
Suction position	axial
Connection standard	DIN 11851 (Milk thread)
Discharge nominal dia.	DN 32
Discharge nominal pressure	PN 10
Discharge position	top (0°/360°)
Discharge flange drilled according to standard	DIN 11851 (Milk thread)
Counter Flange	No
Shaft seal	Single acting mechanical seal
Shaft seal manufacturer	Roten
Shaft seal type	Uniten 3
Mechanical Seal Form	Unbalanced

Direction of rotation	Clockwise
Spring Shrouding	open
Material code	Q1Q1VGG
Shaft seal code	T81
Sealing plan	I Single-acting mechanical seal(internal circulation)
Seal chamber design	Standard seal chamber
Impeller diameter	110.0 mm
Free passage size	4 mm
Direction of rotation from drive	Clockwise
Silicon free pump assembly	Yes
Bearing bracket construction	Close-coupled
Bearing type	Anti-friction bearings
Lubrication type	Grease
Color	White aluminium (similar RAL 9006)
Support or motor foot	3 point ball feet
Motor shroud	Without
Surface finish wetted parts	3.2 µm

VAB 040-032-110 0222KI T81MVCCO OA
 Vitacast Bloc - Hygienic centrifugal pump

Page: 2 / 5

Driver, accessories

Driver type	Electric motor	Motor enclosure	IP55
Drive standard mech.	IEC	Cos phi at 4/4 load	0.86
Model (make)	KSB-Motor	Motor efficiency at 4/4 load	85.9 %
Drive supplied by	Standard motor supplied by KSB - mounted by KSB	Temperature sensor	1 PTC resistor
Motor const. type	V1	Terminal box position	0°/360° (top)
Motor size	90L		Viewed from the drive
Efficiency class	Efficiency class IE3 acc. to IEC60034-30-1	Motor winding	230 / 400 V
Speed control selection	Speed adjustment	Number of poles	2
Frequency	50 Hz	Connection mode	Star
Designed for operation with frequency inverter	Yes	Motor cooling method	Surface cooling
Rated voltage	400 V	Motor material	Aluminium
Rated power P2	2.20 kW	Frequency inverter operation allowed	FI allowed
Available reserve	182.40 %	Motor noise pressure level	68 dBa
Rated current	4.6 A	Motor data can vary from type plate information. Motor data describes KSB's choice functional specification and is used for pump selection.	
Starting current ratio	8.7	EAC Approval	Yes
Insulation class	F to IEC 34-1		

Materials C

Circular casing (103)	Stainless steel 1.4409	Taper locking ring (515)	Stainless steel 1.4301
Discharge cover (163)	Stainless steel 1.4409	Cover plate (68-3)	Stainless steel 1.4301
Shaft (210)	CrNiMo steel 1.4404	Motor shroud (683)	Without
Impeller (230)	Stainless steel 1.4409	Impeller nut (922)	CrNiMo steel 1.4404
O-Ring (412)	FKM 75 with FDA approval		

Packaging

Packaging category	A0 Packing acc. to KSB choice	Packaging for transport	Truck
Packaging for storage	Indoor		

Nameplates

Nameplates language	International
---------------------	---------------

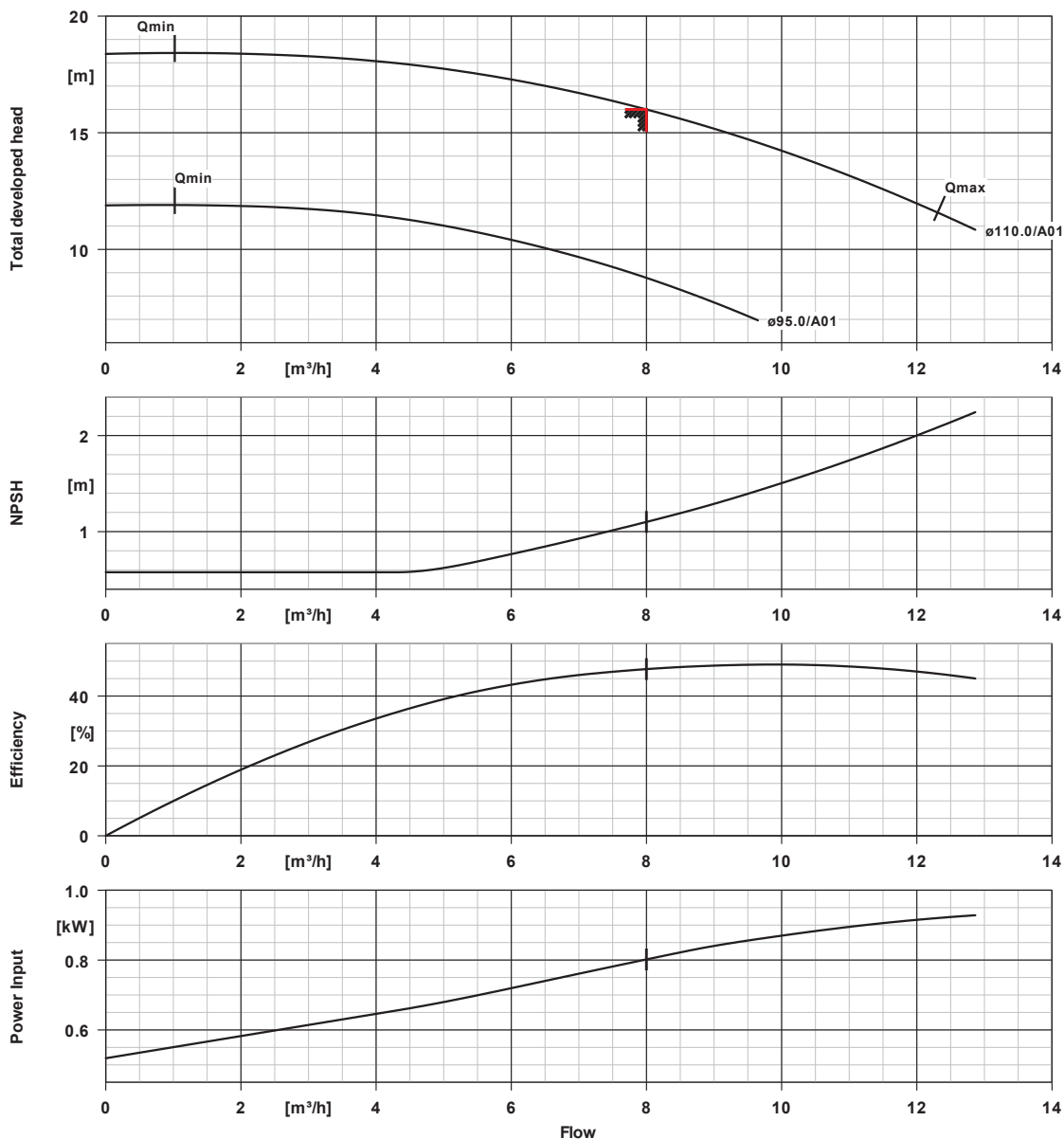

Curve data

Speed of rotation	3117 rpm	Requested developed head	16.00 m
Fluid density	1100 kg/m ³	Efficiency	47.7 %
Viscosity	1.10 mm ² /s	Power absorbed	0.80 kW
Flow rate	8.00 m ³ /h	NPSHR	1.10 m
Requested flow rate	8.00 m ³ /h	Curve number	VA-32110-2900
Total developed head	16.00 m	Effective impeller diameter	110.0 mm

Vitacast Bloc - Hygienic centrifugal pump

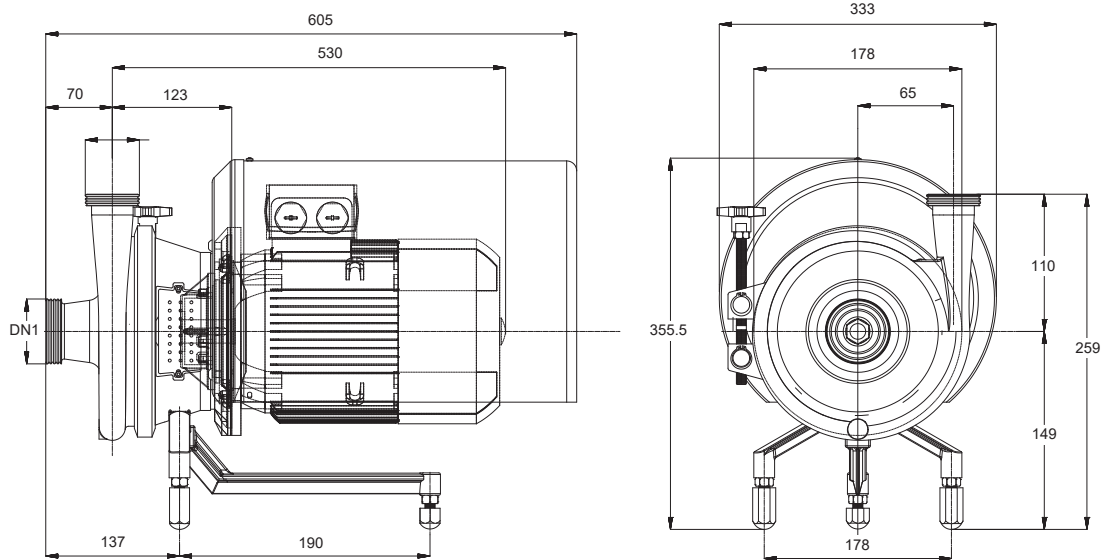

Drawing is not to scale

Dimensions in mm

Motor

Motor manufacturer	KSB-Motor
Motor size	90L
Motor power	2.20 kW
Number of poles	2
Speed of rotation	2961 rpm
Position of terminal box	0°/360° (top)
	Viewed from the drive

Connections

Suction nominal size DN1	DN 40 / DIN 11851 (Milk thread)
Discharge nominal size DN2	DN 32 / DIN 11851 (Milk thread)
Nominal pressure suct.	PN 10
Rated pressure disch.	PN 10

Weight net

Pump	11 kg
Motor	21 kg
Total	32 kg

Connect pipes without stress or strain!

For auxiliary connections see separate drawing.

VAB 040-032-110 0222KI T81MVCCO OA
 Vitacast Bloc - Hygienic centrifugal pump

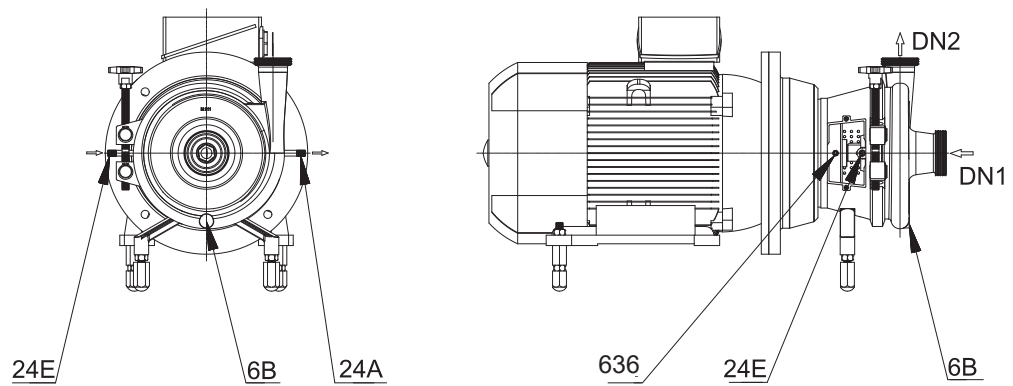

Connections

6B Pumped liquid drain	G 3/8	Not executed
24E/24A Quench liquid in/out	G 1/4	Not executed
10E/10A Sealing liquid in/out	G 1/4	Not executed
636 Lubrication for bearing		Not executed